

Accuphase

Class-A
PRECISION INTEGRATED STEREO AMPLIFIER

E-800S

- Integrated amplifier with fully balanced configuration from input to output
- Balanced AAVA type volume control
- High-accuracy, high-rigidity volume sensor construction
- Power amplification stage configured as an instrumentation amplifier
- Six-fold parallel push-pull configuration using power MOS-FETs driven in Class A
- Linear power output of 50 watts into 8 ohms, 100 watts into 4 ohms, or 200 watts into 2 ohms
- 300 watts output into 1-ohm load
- High damping factor of 1,000
- Strong power supply with massive high-efficiency toroidal transformer and large filtering capacitors
- Protection circuitry using MOS-FET switches





Simply the world's best integrated amplifier

The E-800S is our flagship model that incorporates the full breadth of Accuphase's accumulated knowledge on integrated amplifiers. The preamplifier section incorporates a Balanced AAVA type volume control, while the power amp stage relies on an instrumentation amplifier principle and six-fold parallel push-pull configuration using power MOS-FETs driven in Class A, driving any loudspeakers to higher dimensions of sound. Enjoy the blissful acoustic space provided during playback with the E-800S.

Innovation - At the leading edge of technology

Balanced AAVA type volume control circuit

Conventional preamplifiers use variable resistors to adjust volume, which can cause contacts to deteriorate and create rasping as well as increase noise at normal volume levels. AAVA, however, produces multiple, widely varying signals from the input signal and controls volume by changing the combination of those signals. This achieves minimum noise at all volume levels without any rasping. The E-800S relies on Balanced AAVA comprised of balanced AAVA circuits, reducing the overall noise level by 10% compared to conventional models at typical volume positions.

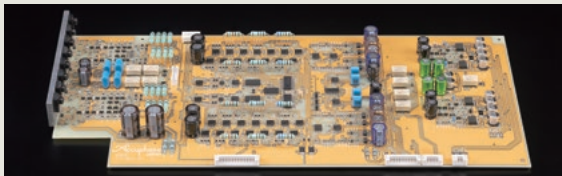

Balanced AAVA type volume control circuit

High-accuracy, high-rigidity volume sensor construction

The volume sensor mechanism carved from a single aluminum block ensures silky-smooth operation, a weighty operational feel, and accurate position detection. Operations with the remote commander are so quiet that mechanical noise is hardly noticeable.

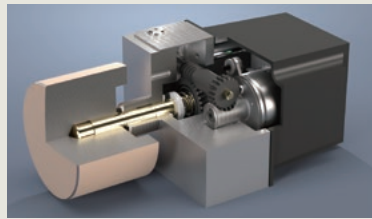

Volume sensor construction

ANCC significantly reduces distortion and noise (Accuphase Noise and distortion Canceling Circuit)

The E-800S's I-V conversion amplifier uses the ANCC principle. ANCC uses a secondary amplifier to cancel out noise and distortion from the main amplifier. The secondary amplifier utilizes a low-noise amplifier (noise density: 1.5 nV/√Hz) to increase the effect of the ANCC. Incorporating this ANCC in the AAVA I-V conversion amplifier drastically improves noise performance, particularly when transitioning from low volume settings to typical volume positions.

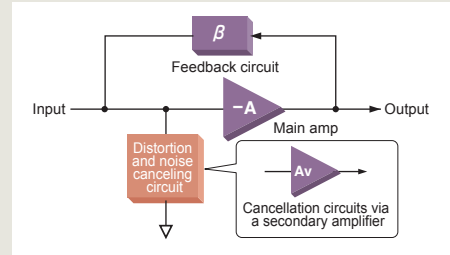

Block diagram of ANCC

Power amplification stage configured as an instrumentation amplifier

The instrumentation amplifier circuitry's equal impedance on the + and - sides and exceptional external noise suppression provide optimal performance for an audio amplifier.

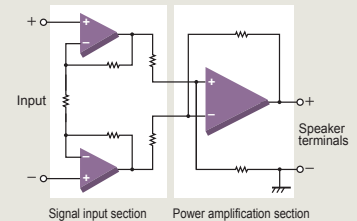

Sound quality - Simply aiming for the best

Power amplification stage that achieves linear output

The power amplification stage on both the left and right sides features a large heat sink and employs six-fold parallel push-pull MOS-FETs driven in Class A to provide linear power output of 50 watts into 8 ohms, 100 watts into 4 ohms, and 200 watts into 2 ohms.

Power supply circuitry delivers steady power

A strong power supply featuring a massive toroidal transformer and two high-voltage, large filtering capacitors (63,000 μF/63 V) offer a stable power supply at all times.

High damping factor brings out the full potential of speakers

The damping factor represents the amplifier's ability to drive the speakers. A damping factor of 1,000 (guaranteed) extracts the maximum potential from the loudspeakers.

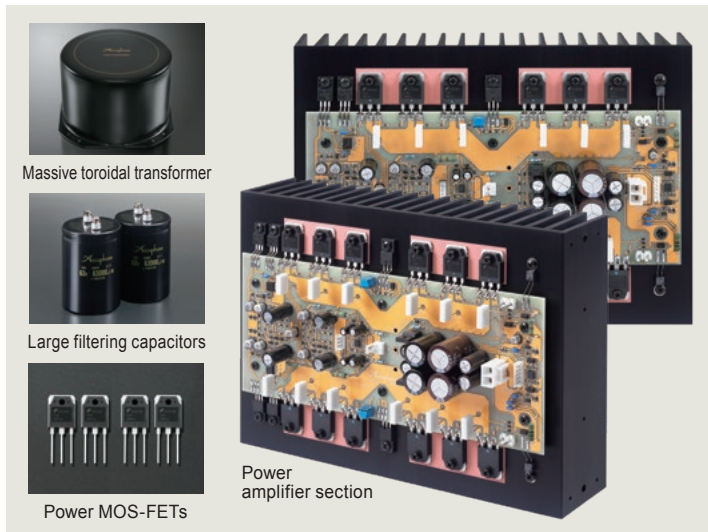

Bold Appearance,



Graceful Sound



Advanced features

- Balanced AAVA volume control circuit
- High-accuracy, high-rigidity volume sensor construction
- Highly reliable logic-control signal switching relays
- Power amplification stage configured as an instrumentation amplifier
- Balanced remote sensing to improve the damping factor
- Current feedback amplification circuit topology assures excellent phase characteristics in the high range
- Pre-amplifier I/O terminals (LINE / BALANCED)
- Dedicated, high-quality headphone amplifier with discrete circuitry
- -20 dB volume attenuator to instantly reduce the sound level
- Speaker output selector
- Tone controls using summing active filters
- Individual phase setting for each input
- Stereo signal can be switched to monophonic
- Loudness compensator to adjust audible energy balance
- Display mode selector
- DAC input selector (when DAC-60 / DAC-50 / DAC-40 is installed)
- MC/MM selector (when AD-60 / AD-50 / AD-30 / AD-20 is installed)
- Subsonic filter ON/OFF selector (when AD-60 is installed)
- MC input impedance selector
- Left/right balance control using AAVA
- Power amp section input selector (LINE / BALANCED)
- Recorder selector
- Volume display
- Sampling frequency display (when DAC-60 / DAC-50 / DAC-40 is installed)
- Five sets of line inputs
- Speaker output protection circuit guards against short-circuiting
- Three sets of balanced inputs
- Two sets of large speaker terminals
- Highly-sensitive LED power meters capable of displaying output levels to -50 dB
- Highly reliable MOS-FET switches
- High-carbon cast iron insulators for superior vibration damping

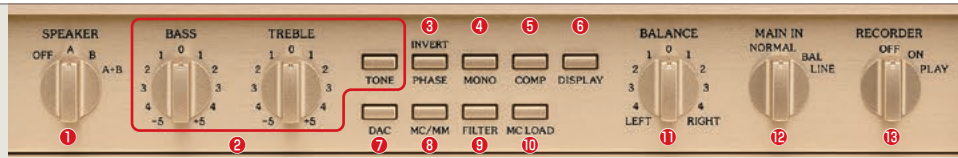

14 Volume display



15 Sampling frequency display

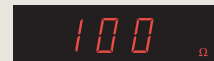

16 MC input impedance display

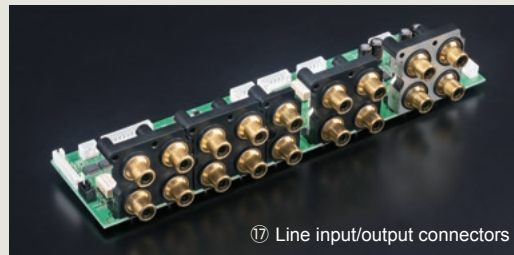

17 Line input/output connectors

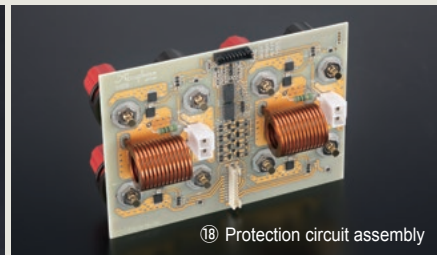

18 Protection circuit assembly

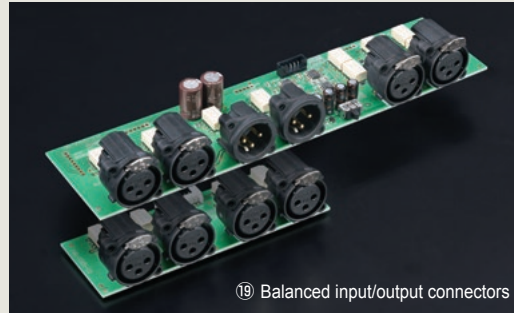

19 Balanced input/output connectors



20 Speaker terminals connected directly to protection circuitry



21 Bar graph power meter



22 MOS-FET switches



23 High-carbon cast iron insulators

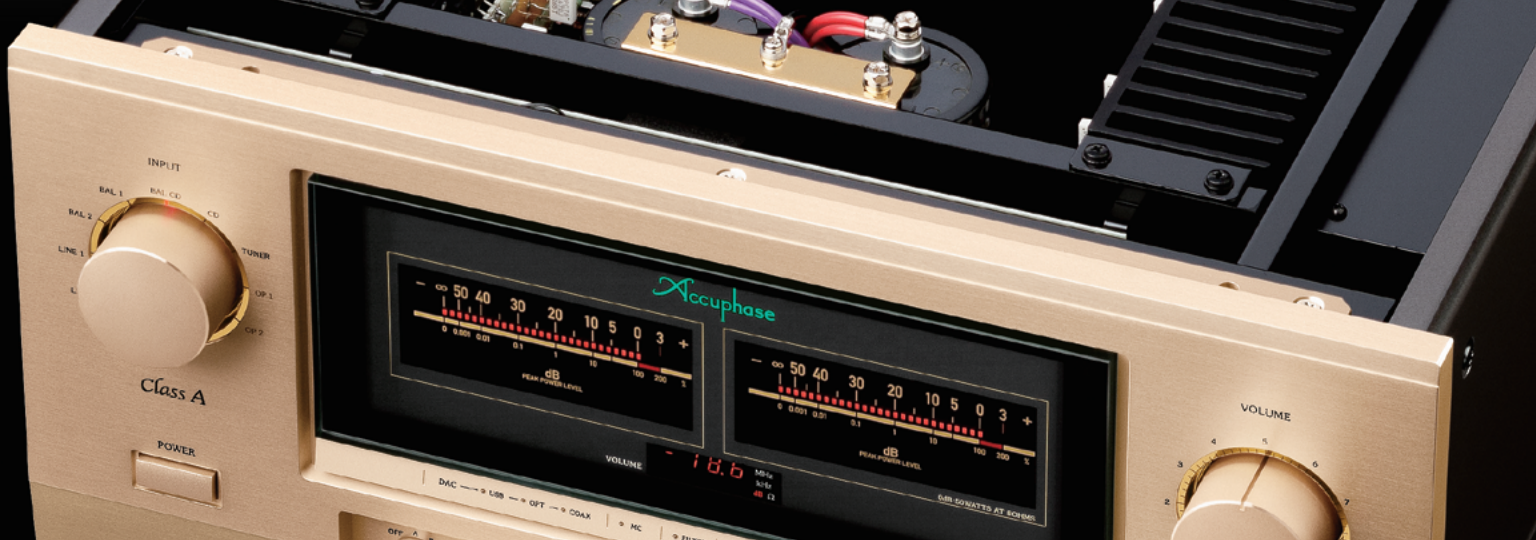
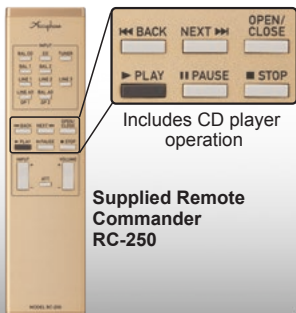

Bi-amping for Further Enhanced Sound

In a bi-amped setup, the speaker units for the Low range and the High range are driven by separate amplifiers with equal gain, enabling playback with higher sound quality.

*The speakers must have a built-in crossover network and separate inputs for the Low and High ranges.

*The example shows a setup with an additional power amplifier for the Low range.

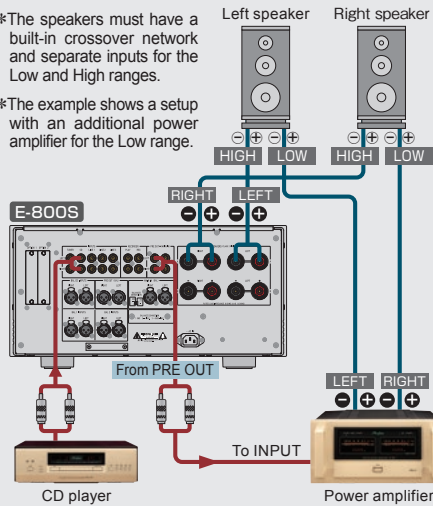

Option Boards



The rear panel expansion slots allow use of three types of option boards: DAC-60, AD-60, and LINE-10. The E-800S can accommodate two boards according to the requirements.

■ The following option boards can also be used

Digital Input Board	DAC-50/DAC-40/ DAC-30/DAC-20/ DAC-10
Analog Record Input Board	AD-50/AD-30/ AD-20/AD-10/AD-9
Line Input Board	LINE-9

Analog Record Input Board AD-60



Features a high-performance phono equalizer for playback of analog records.

- Supports MC and MM cartridges
- Load impedance selection (MC only)
- Subsonic filter

Cartridge	MC	MM
Gain	66 dB	40 dB
Input Impedance	30 ohms	47 kilohms
	100 ohms	
	200 ohms	
	300 ohms	

Digital Input Board DAC-60

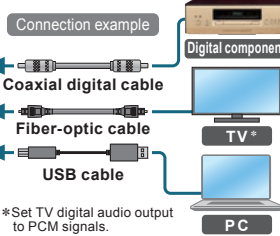

High-performance DAC with two ES9016K2M chips from ESS Technology driven in parallel.

Input	Signal	Sampling Frequencies	Number of Bits
USB	DSD	2.8 MHz	1-bit
		5.6 MHz	
		11.2 MHz	
		[11.2 MHz: ASIO only]	
OPTICAL	PCM	32 to 384 kHz	32-bit
		32 to 96 kHz	24-bit
COAXIAL	PCM	32 to 192 kHz	24-bit

* Set TV digital audio output to PCM signals.

Line Input Board LINE-10



Provides an additional set of unbalanced line level inputs.

Front Panel

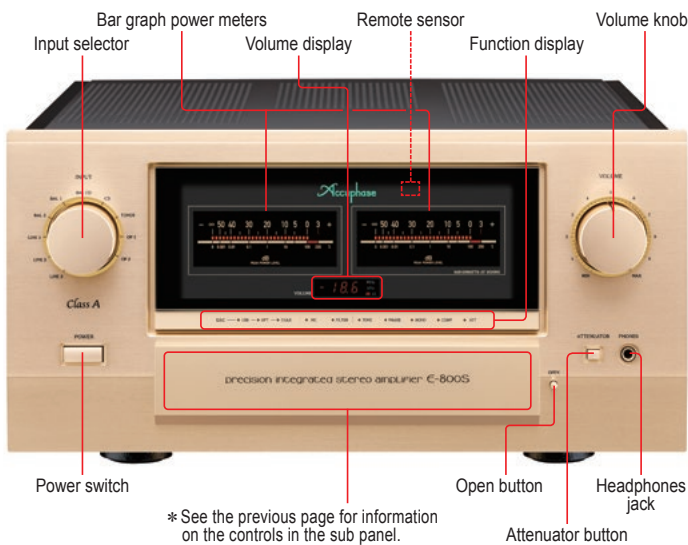

* See the previous page for information on the controls in the sub panel.

Rear Panel

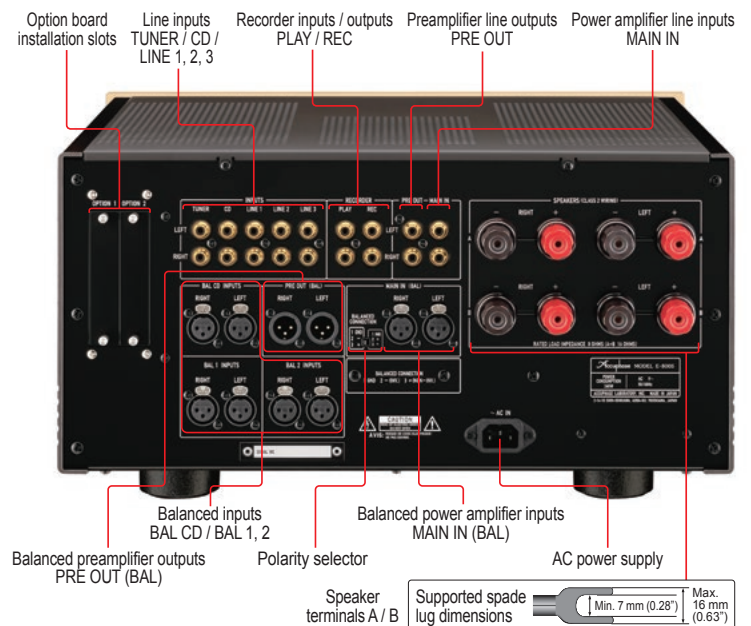

E-800S Guaranteed Specifications

Rated Output (20 to 20,000 Hz)	Both channels driven simultaneously	1-ohm load*	300 W/ch
		2-ohm load*	200 W/ch
		4-ohm load*	100 W/ch
		8-ohm load	50 W/ch
Total Harmonic Distortion (20 to 20,000 Hz, rated output)	Both channels driven simultaneously	2-ohm load	0.05 %
		4 to 16-ohm load	0.03 %
Intermodulation Distortion		0.01%	
Frequency Response	At rated output	INPUT (BALANCED / LINE)	20 to 20,000 Hz (+0, -0.5 dB)
		MAIN IN (BALANCED / LINE)	20 to 20,000 Hz (+0, -0.2 dB)
	At 1 W output	MAIN IN (BALANCED / LINE)	3 to 150,000 Hz (+0, -3.0 dB)
Damping Factor		1,000	
Input Sensitivity	At rated output	INPUT (BALANCED / LINE)	100 mV
		MAIN IN (BALANCED / LINE)	796 mV
	EIA (at 1 W output)	INPUT (BALANCED / LINE)	14.2 mV
		MAIN IN (BALANCED / LINE)	113 mV
Input Impedance	INPUT (BALANCED)		40 kilohms
	INPUT (LINE)		20 kilohms
	MAIN IN (BALANCED)		40 kilohms
	MAIN IN (LINE)		20 kilohms
Max. Input Voltage	INPUT (BALANCED / LINE)		5.0 V
Output Voltage	At rated output	PRE OUTPUT (BALANCED / LINE)	796 mV
Output Impedance	PRE OUTPUT (BALANCED / LINE)		50 ohms

Gain	INPUT (BALANCED / LINE) → PRE OUTPUT (BALANCED / LINE)	18 dB	
	MAIN IN (BALANCED / LINE) → SPEAKER OUTPUT	28 dB	
Tone Controls	Turnover frequency and adjustment range	Bass: 300 Hz	
		Treble: 3 kHz	
Loudness Compensator	+6 dB (100 Hz)		
Attenuator	-20 dB		
S/N Ratio	At rated output (Input shorted, A weighting)	INPUT (BALANCED / LINE)	105 dB
		MAIN IN (BALANCED / LINE)	120 dB
	EIA	INPUT (BALANCED / LINE)	97 dB
		MAIN IN (BALANCED / LINE)	101 dB
Power Meters	Bar graph meters, Output voltage (dB) using 30 points, with ON/OFF switch		
Headphones Jack	Compatible impedance	8 ohms or higher	
Power Requirements	120 V, 220 V, 230 V AC (voltage as indicated on rear panel)		
	50 / 60 Hz		
Power Consumption	Idle	190 W	
	In accordance with IEC 62368-1	260 W	
	Stand-by	0.3 W	
Maximum Dimensions	Width 465 mm (18.3") × Height 239 mm (9.4") × Depth 502 mm (19.8")		
	Net	35.7 kg (78.7 lbs)	
Mass	In shipping carton		
		45 kg (100 lbs)	

* Music signals only

• Measurement methods for Guaranteed Specifications adhere to JEITA CP-1301A and IEC 60268-3.

Supplied accessories

- AC power cord (2 m (6.5'))
- Remote Commander RC-250

Remarks

★ This product is available in versions for 120/220/230 V AC. Make sure that the voltage shown on the rear panel matches the AC line voltage in your area.

★ The 230 V version has an Eco Mode that switches power off after 120 minutes of inactivity.

★ The shape of the plug of the supplied AC power cord depends on the voltage rating and destination country.



ACCUPHASE LABORATORY, INC.

• The specifications and appearance of this product are subject to change without notice.

https://www.accuphase.com

K2406Y 850-2242-00 (B1) PRINTED IN JAPAN